

Mark For: _____

Submitting for: Quote Order

Date: _____

PO#: _____

Dealer Acct #: _____

Dealer: _____

Dealer Contact: _____

Dealer Address: _____

Dealer City: _____

ST: _____

ZIP: _____

Dealer Phone: () _____

Fax: () _____

Confirmation Email: _____

Confirm Via: Fax Email

ADDITIONAL SHIPPING INFORMATION

Ship To: _____

Attention: _____

Address: _____

Address: _____

Ship To City: _____

ST: _____

ZIP: _____

Ship To Phone: () _____

Fax: () _____

The **HCPCS CODES** provided are based on code verification through PDAC or our interpretation of the code definitions.

The use of **HCPCS CODES** does not ensure coverage or payment. For coverage information, verify the appropriate payer's coverage policy.

Note: For cover selection, **L** = Lycra and **V** = Dartex Reversed (Example: AXYS-HUFALL or AXYS-HUFAL V)

Head Positioning - Use HCPCS Code E0955

Whitmyer headrests come unassembled. Please add item WHITASSY001 if the dealer would like parts assembled. This is a no charge option.

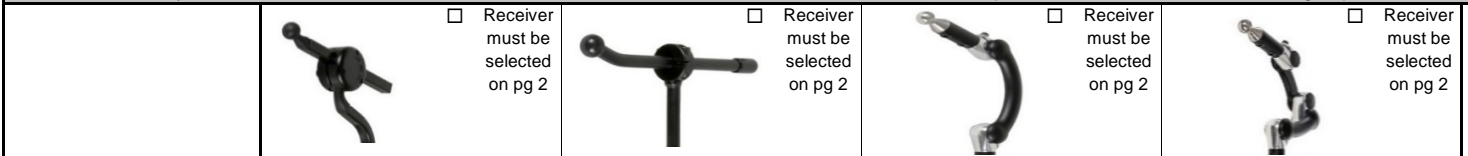

| | | | | |
|------------|-------------|-------------|-------------|-------------------------|
| PAD | AXYS | ONYX | LINX | LINX² |
|------------|-------------|-------------|-------------|-------------------------|

| | | | | | |
|-----------------------|--------|---|---|---|--|
| CONTOUR CRADLE | Large | <input type="checkbox"/> AXYS-CCS4L \$200 | <input type="checkbox"/> ONYX-CCS4L \$200 | <input type="checkbox"/> LINX-CCS4L \$155 | <input type="checkbox"/> LINX2-CCS4L \$190 |
| | Medium | <input type="checkbox"/> AXYS-CCS4V \$200 | <input type="checkbox"/> ONYX-CCS4V \$200 | <input type="checkbox"/> LINX-CCS4V \$155 | <input type="checkbox"/> LINX2-CCS4V \$190 |
| | Small | <input type="checkbox"/> AXYS-CCS3L \$190 | <input type="checkbox"/> ONYX-CCS3L \$190 | <input type="checkbox"/> LINX-CCS3L \$145 | <input type="checkbox"/> LINX2-CCS3L \$180 |
| | | <input type="checkbox"/> AXYS-CCS3V \$190 | <input type="checkbox"/> ONYX-CCS3V \$190 | <input type="checkbox"/> LINX-CCS3V \$145 | <input type="checkbox"/> LINX2-CCS3V \$180 |
| | | <input type="checkbox"/> AXYS-CCS2L \$180 | <input type="checkbox"/> ONYX-CCS2L \$180 | <input type="checkbox"/> LINX-CCS2L \$135 | <input type="checkbox"/> LINX2-CCS2L \$170 |
| | | <input type="checkbox"/> AXYS-CCS2V \$180 | <input type="checkbox"/> ONYX-CCS2V \$180 | <input type="checkbox"/> LINX-CCS2V \$135 | <input type="checkbox"/> LINX2-CCS2V \$170 |

| | | | | | |
|----------------|--------|---|---|---|--|
| C-PLUSH | Large | <input type="checkbox"/> AXYS-CCP4L \$200 | <input type="checkbox"/> ONYX-CCP4L \$200 | <input type="checkbox"/> LINX-CCP4L \$155 | <input type="checkbox"/> LINX2-CCP4L \$190 |
| | Medium | <input type="checkbox"/> AXYS-CCP4V \$200 | <input type="checkbox"/> ONYX-CCP4V \$200 | <input type="checkbox"/> LINX-CCP4V \$155 | <input type="checkbox"/> LINX2-CCP4V \$190 |
| | Small | <input type="checkbox"/> AXYS-CCP3L \$190 | <input type="checkbox"/> ONYX-CCP3L \$190 | <input type="checkbox"/> LINX-CCP3L \$145 | <input type="checkbox"/> LINX2-CCP3L \$180 |
| | | <input type="checkbox"/> AXYS-CCP3V \$190 | <input type="checkbox"/> ONYX-CCP3V \$190 | <input type="checkbox"/> LINX-CCP3V \$145 | <input type="checkbox"/> LINX2-CCP3V \$180 |
| | | <input type="checkbox"/> AXYS-CCP2L \$180 | <input type="checkbox"/> ONYX-CCP2L \$180 | <input type="checkbox"/> LINX-CCP2L \$135 | <input type="checkbox"/> LINX2-CCP2L \$170 |
| | | <input type="checkbox"/> AXYS-CCP2V \$180 | <input type="checkbox"/> ONYX-CCP2V \$180 | <input type="checkbox"/> LINX-CCP2V \$135 | <input type="checkbox"/> LINX2-CCP2V \$170 |

| | | | |
|------------------------------|--|--|------------|
| CONTOUR CRADLE INFANT | <input type="checkbox"/> AXYS-CCS1 \$180 | <input type="checkbox"/> ONYX-CCS1 \$180 | N/A |
|------------------------------|--|--|------------|

Head Positioning - Use HCPCS Code E0955

Whitmyer headrests come unassembled. Please add item WHITASSY001 if the dealer would like parts assembled. This is a no charge option.







| | | | |
|------------|------------|--------------|-----------------|
| PAD | PRO | COBRA | COBRA-FB |
|------------|------------|--------------|-----------------|

| | | | | |
|-----------------------|--------|--|--|---|
| CONTOUR CRADLE | Large | <input type="checkbox"/> PRO-CCS4L \$230 | <input type="checkbox"/> COBRA-CCS4L \$430 | <input type="checkbox"/> FB-COBRA-CCS4L \$530 |
| | Medium | <input type="checkbox"/> PRO-CCS4V \$230 | <input type="checkbox"/> COBRA-CCS4V \$430 | <input type="checkbox"/> FB-COBRA-CCS4V \$530 |
| | Small | <input type="checkbox"/> PRO-CCS3L \$230 | <input type="checkbox"/> COBRA-CCS3L \$430 | <input type="checkbox"/> FB-COBRA-CCS3L \$530 |
| | | <input type="checkbox"/> PRO-CCS3V \$230 | <input type="checkbox"/> COBRA-CCS3V \$430 | <input type="checkbox"/> FB-COBRA-CCS3V \$530 |
| | | <input type="checkbox"/> PRO-CCS2L \$230 | <input type="checkbox"/> COBRA-CCS2L \$430 | <input type="checkbox"/> FB-COBRA-CCS2L \$530 |
| | | <input type="checkbox"/> PRO-CCS2V \$230 | <input type="checkbox"/> COBRA-CCS2V \$430 | <input type="checkbox"/> FB-COBRA-CCS2V \$530 |

| | | | | |
|----------------|--------|--|--|---|
| C-PLUSH | Large | <input type="checkbox"/> PRO-CCP4L \$230 | <input type="checkbox"/> COBRA-CCP4L \$430 | <input type="checkbox"/> FB-COBRA-CCP4L \$530 |
| | Medium | <input type="checkbox"/> PRO-CCP4V \$230 | <input type="checkbox"/> COBRA-CCP4V \$430 | <input type="checkbox"/> FB-COBRA-CCP4V \$530 |
| | Small | <input type="checkbox"/> PRO-CCP3L \$230 | <input type="checkbox"/> COBRA-CCP3L \$430 | <input type="checkbox"/> FB-COBRA-CCP3L \$530 |
| | | <input type="checkbox"/> PRO-CCP3V \$230 | <input type="checkbox"/> COBRA-CCP3V \$430 | <input type="checkbox"/> FB-COBRA-CCP3V \$530 |
| | | <input type="checkbox"/> PRO-CCP2L \$230 | <input type="checkbox"/> COBRA-CCP2L \$430 | <input type="checkbox"/> FB-COBRA-CCP2L \$530 |
| | | <input type="checkbox"/> PRO-CCP2V \$230 | <input type="checkbox"/> COBRA-CCP2V \$430 | <input type="checkbox"/> FB-COBRA-CCP2V \$530 |

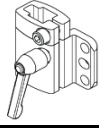



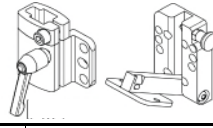
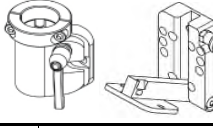
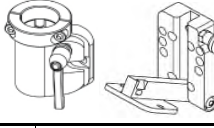
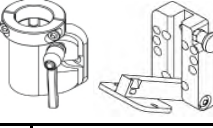



Mounting Brackets - Use HCPCS Code E1028

Head Support System Mounting Brackets must be ordered separately, except for COBRA

| | AXYS | ONYX | LINX & LINX ² | PRO | COBRA mounting system includes detachable mounting bracket |
|---|---|---|--|---|--|
| REMOVABLE MOUNTING BRACKET (PART SOLD SEPARATELY FROM POST & PAD) |  |  |  |  | |
| Detachable | <input type="checkbox"/> M2500 \$105 | <input type="checkbox"/> M2100-WB \$85 | <input type="checkbox"/> M2300 \$165 | <input type="checkbox"/> M2200-WB \$185 | |
| REMOVABLE & SWING-AWAY MNT BRACKET (PART SOLD SEPARATELY FROM POST & PAD) |  |  |  |  | |
| Swing-Away | <input type="checkbox"/> M5500 \$200 | <input type="checkbox"/> M5100 \$185 | <input type="checkbox"/> M5300 \$265 | <input type="checkbox"/> M5200 \$285 | |

Lateral Facial Supports

Note: Cover Selection - Add L = Lycra or V = Dartex Reversed (Example: LFC-PLL)



| | SPOT | STANDARD | LONG | OVAL | LARGE-C | MED-C | SMALL-C | FSO-B |
|---|---|---|---|---|---|---|---|--|
|  |  |  |  |  |  |  |  | |
| Unilateral | <input type="checkbox"/> LFC10-CSL \$220 LM115 \$80 | <input type="checkbox"/> LFC15-CSL \$220 LM115 \$80 | <input type="checkbox"/> LFC20-CSL \$220 LM115 \$80 | <input type="checkbox"/> LFC25-CSL \$220 LM115 \$80 | <input type="checkbox"/> LFC30-CSL \$220 LM115 \$80 | <input type="checkbox"/> LFC35-CSL \$220 LM115 \$80 | <input type="checkbox"/> LFC40-CSL \$220 LM115 \$80 | <input type="checkbox"/> LFC80-CS \$255 LM115 \$80 |
| Bilateral | <input type="checkbox"/> LFC10-CS2L \$410 LM115 \$80 LM115 \$80 | <input type="checkbox"/> LFC15-CS2L \$410 LM115 \$80 LM115 \$80 | <input type="checkbox"/> LFC20-CS2L \$410 LM115 \$80 LM115 \$80 | <input type="checkbox"/> LFC25-CS2L \$410 LM115 \$80 LM115 \$80 | <input type="checkbox"/> LFC30-CS2L \$410 LM115 \$80 LM115 \$80 | <input type="checkbox"/> LFC35-CS2L \$410 LM115 \$80 LM115 \$80 | <input type="checkbox"/> LFC40-CS2L \$410 LM115 \$80 LM115 \$80 | <input type="checkbox"/> LFC80-CS2 \$469 LM115 \$80 LM115 \$80 |
| Pad Only* | <input type="checkbox"/> PL10L \$70 <input type="checkbox"/> PL10V \$70 | <input type="checkbox"/> PL15L \$100 <input type="checkbox"/> PL15V \$100 | <input type="checkbox"/> PL20L \$100 <input type="checkbox"/> PL20V \$100 | <input type="checkbox"/> P600L \$100 <input type="checkbox"/> P600V \$100 | <input type="checkbox"/> PL30L \$100 <input type="checkbox"/> PL30V \$100 | <input type="checkbox"/> PL35L \$100 <input type="checkbox"/> PL35V \$100 | <input type="checkbox"/> PL40L \$90 <input type="checkbox"/> PL40V \$90 | N/A |

LATERAL FACIAL SUPPORT PARTS

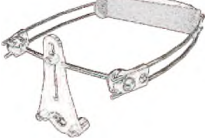

*Note: If ordering an additional Lateral Facial Support, select both a Lateral Facial Support Pad Only from above and an Infinity Mount from below as well

| Option # | Definition | Price |
|---------------------------------|-------------------------------|-------|
| <input type="checkbox"/> 242161 | Infinity Dual Mount Assembly* | \$195 |
| <input type="checkbox"/> LM1010 | Lateral Facial Support* | \$125 |

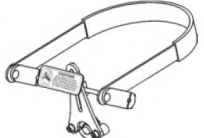
ANTERIOR HEAD SUPPORT

| | DYNAMIC FOREHEAD STRAP | DFS ² | STRAP CAP | STATIC FOREHEAD STRAP |
|---|---|--|---|-------------------------------------|
|  |  |  |  | |
| ADULT | <input type="checkbox"/> DFS10 \$289 | <input type="checkbox"/> DFSQ10 \$349 | <input type="checkbox"/> CAP10 (black) \$400 | <input type="checkbox"/> HU10 \$315 |
| PEDS | <input type="checkbox"/> DFS30 \$289 | <input type="checkbox"/> DFSQ30 \$349 | <input type="checkbox"/> CAP30-R (red) \$400 | |
| | | | <input type="checkbox"/> CAP30-B (blue) \$400 | |

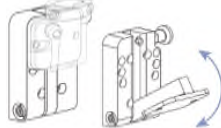
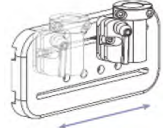
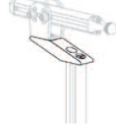

CUSTOM MOUNTING OPTIONS

| | | | | |
|--|---|---|---|---|
|  |  |  |  |  |
| FLEX INTERFACE BRACKET | UNIVERSAL SWING-AWAY MOUNT | SLIDE MOUNT | PRO OFF-SET MOUNTING SYSTEM | ONYX REARWARD OFF-SET VERTICAL ROD |
| <input type="checkbox"/> M9450 (hard) \$185 <input type="checkbox"/> M8451 (soft) \$185 | <input type="checkbox"/> M5000 \$100 | <input type="checkbox"/> M7010 \$95 | <input type="checkbox"/> PRC7070 \$163 | <input type="checkbox"/> OX6030 \$60 |

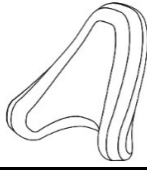

TOOLS

| <input checked="" type="checkbox"/> | Option # | Definition | Price |
|-------------------------------------|-----------|------------|--------|
| <input type="checkbox"/> | BOLT LUBE | Bolt Lube | \$0 |
| <input type="checkbox"/> | T2500 | Tool Kit | \$3.33 |

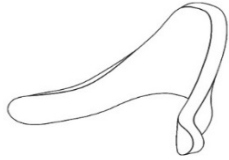
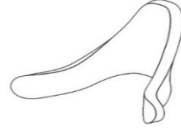
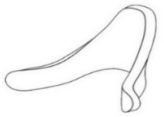

Pad Styles

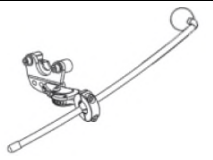
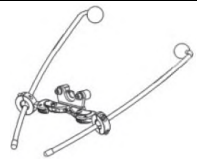
| | | | |
|-----------------------|---|--|---|
| C-PLUSH |  |  |  |
| | Large CCP4 7"w X 5"h | Medium CCP3 6"w X 4-1/2"h | Small CCP2 5"w X 4"h |
| CONTOUR CRADLE |  |  |  |
| | Large CCS4 13"w X 7-1/2"h | Medium CCS3 10"w X 6-1/4"h | Small CCS2 8-1/2"w X 5-1/2"h |

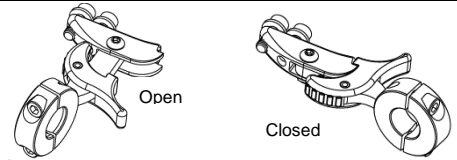
Lateral Facial Supports

| | | | | |
|--------------------------|--|--|--|--|
| MOUNTING HARDWARE |  |  |  |  |
| | Unilateral | Bilateral | Infinity Mount | Swing-Away Mount LM115 |

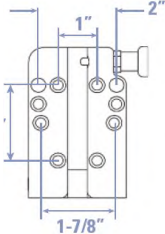
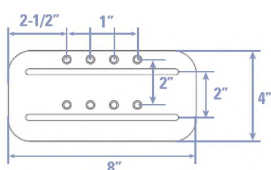
CUSTOM MOUNTS

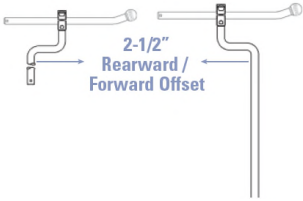
| | | | |
|---|---|--|---|
|  |  |  |  |
| UNIVERSAL SWING-AWAY MOUNT | SLIDE MOUNT | PRO OFF-SET MOUNTING SYSTEM | ONYX REARWARD OFF-SET VERTICAL ROD |



Sunrise Medical (US) LLC
2842 Business Park Ave. · Fresno, CA 93727 · USA