

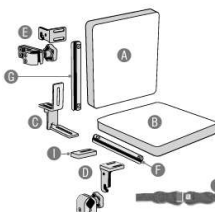
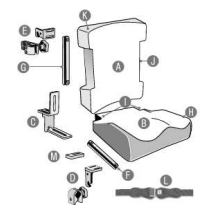
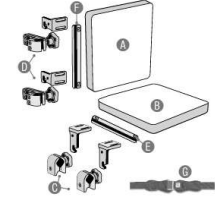

**SEATING SYSTEMS PACKAGES (Seat & Back)**

<input type="checkbox"/>	PKG40XX	E2609/E2617	Li'l Kiddos Seating System Package	\$2,436
				
	A	SBP11XX	Solid Back Insert	\$478
	B	SSP11XX	Solid Seat Insert	\$462
	C	HDW1055	Std Seat To Back brkt	\$427
	D	HDW7819S	Fix Univrsl Clamp (Pr)	\$333
	E	HDW7820	Adj Univrsl Clamp (Pr)	\$427
	F	HDW7110T	10" Adjustment Rails (2)	\$65
	G	HDW7112T	12" Adjustment Rails (2)	\$65
	H	APB5115	Pelvic Belt 1", Padded	\$145
	I	HDW6305	Seat Tab (2)	2x \$17
<p>Note: When WC20 is added appropriate transit approved hardware must be selected.</p>				

<input type="checkbox"/>	PKG41XX	E2609/E2617	Li'l Kiddos Contoured Seating Package	\$3,414
				
	A	SBP11XX	Solid Back Insert	\$478
	B	SSP11XX	Solid Seat Insert	\$462
	C	HDW1055	Std Seat To Back brkt	\$427
	D	HDW7819S	Fix Univrsl Clamp(Pr)	\$333
	E	HDW7820	Adj Univrsl Clamp (Pr)	\$427
	F	HDW7110T	10" Adjustment Rails (2)	\$65
	G	HDW7112T	12" Adjustment Rails (2)	\$65
	H	MOD4600	Contour Seat	\$521
	I	MOD4153	Notches for Back Post	\$0
	J	MOD5200	I Style Back	\$182
	K	MOD5530	Curved Foam Back	\$275
	L	APB5115	Pelvic Belt 1", Padded	\$145
	M	HDW6305	Seat Tab (2)	2x \$17
<p>Note: When WC20 is added appropriate transit approved hardware must be selected.</p>				

<input type="checkbox"/>	PKG42XX	E2609/E2617	Li'l Kiddos Independent St & Back Pkg	\$2,735
				
	A	SBP11XX	Solid Back Insert	\$478
	B	SSP11XX	Solid Seat Insert	\$462
	C	HDW7819S	Fix Universal Clamp(4)	2x \$333
	D	HDW7820	Adj Universal Clamp (4)	2x \$427
	E	HDW7110T	10" Adjustment Rails (2)	\$65
	F	HDW7112T	12" Adjustment Rails (2)	\$65
	G	APB5115	Pelvic Belt 1", Padded	\$145
<p>Note: When WC20 is added appropriate transit approved hardware must be selected.</p>				

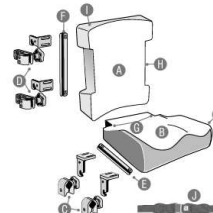
<input type="checkbox"/>	PKG43XX	E2609/E2617	Li'l Kiddos Contoured Indp St & Bck Pkg	\$3,713
				
	A	SBP11XX	Solid Back Insert	\$478
	B	SSP11XX	Solid Seat Insert	\$462
	C	HDW7819S	Fix Universal Clamp(4)	2x \$333
	D	HDW7820	Adj Universal Clamp (4)	2x \$427
	E	HDW7110T	10" Adjustment Rails (2)	\$65
	F	HDW7112T	12" Adjustment Rails (2)	\$65
	G	MOD4153	Notches for Back Post	\$0
	H	MOD5200	I Style Back	\$182
	I	MOD5530	Curved Foam Back	\$275
	J	APB5115	Pelvic Belt 1", Padded	\$145
	K	MOD4600	Contour Seat	\$521
<p>Note: When WC20 is added appropriate transit approved hardware must be selected.</p>				

**SEAT PACKAGES**

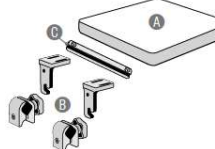
<input type="checkbox"/>	SSK70XX	E2609	Li'l Kiddos Solid Seat Package	\$1,193
				
	A	SSP11XX	Solid Seat Insert	\$462
	B	HDW7819S	Fix Universal Clamp(4)	2x \$333
	C	HDW7110T	10" Adjustment Rails (2)	\$65
<p>Note: When WC20 is added appropriate transit approved hardware must be selected.</p>				

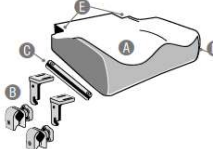
<input type="checkbox"/>	SSK71XX	E2609	Li'l Kiddos Contoured Seat Package	\$1,381
				
	A	SSP11XX	Solid Seat Insert	\$462
	B	HDW7819S	Fix Universal Clamp(4)	2x \$333
	C	HDW7110T	10" Adjustment Rails (2)	\$65
	D	MOD4600	Contour Seat	\$521
	E	MOD4153	Notches for Back Post	\$0
<p>Note: When WC20 is added appropriate transit approved hardware must be selected.</p>				

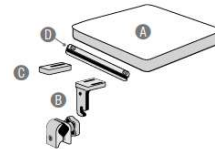
<input type="checkbox"/>	SSK77XX	E2609	Li'l Kiddos Seat & Hardware Package	\$1,013
				
	A	SSP11XX	Solid Seat Insert	\$462
	B	HDW7819S	Fix Univrsl Clamp (Pr)	\$333
	C	HDW6305	Seat Tab (2)	2x \$17
	D	HDW7110T	10" Adjustment Rails (2)	\$65
<p>Note: When WC20 is added appropriate transit approved hardware must be selected.</p> <p>Note: Configured to be ordered with SBK77XX or SBK78XX</p>				

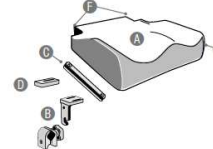
<input type="checkbox"/>	SSK78XX	E2609	Li'l Kiddos Contoured Seat Package	\$1,415
				
	A	SSP11XX	Solid Seat Insert	\$462
	B	HDW7819S	Fix Univrsl Clamp (Pr)	\$333
	C	HDW7110T	10" Adjustment Rails (2)	\$65
	D	HDW6305	Seat Tab (2)	2x \$17
	E	MOD4600	Contour Seat	\$521
	F	MOD4153	Notches for Back Post	\$0
<p>Note: When WC20 is added appropriate transit approved hardware must be selected.</p> <p>Note: Configured to be ordered with SBK77XX or SBK78XX</p>				

**BACK PACKAGES**

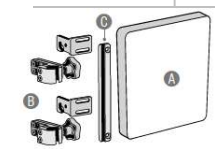
<input type="checkbox"/>	SBK70XX	E2617	Universal Mount Back Package	\$1,397
				
	A	SBP11XX	Solid Back Insert	\$478
	B	HDW7820	Adj Universal Clamp (4)	2x \$427
	C	HDW7112T	12" Adjustment Rails (2)	\$65
<p>Note: When WC20 is added appropriate transit approved hardware must be selected.</p>				

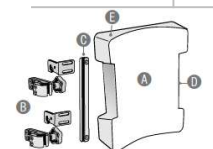
<input type="checkbox"/>	SBK71XX	E2617	Drop Hook & Fixed Holds(Between)	\$1,854
				
	A	SBP11XX	Solid Back Insert	\$478
	B	HDW7820	Adj Universal Clamp (4)	2x \$427
	C	HDW7112T	12" Adjustment Rails (2)	\$65
	D	MOD5200	I Style Back	\$182
	E	MOD5530	Curved Foam Back	\$275
<p>Note: When WC20 is added appropriate transit approved hardware must be selected.</p>				

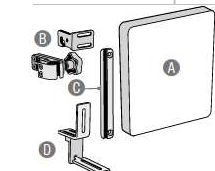
<input type="checkbox"/>	SBK77XX	E2617	Adj "J" Hook & Fixed/Rotate Hold	\$1,397
				
	A	SBP11XX	Solid Back Insert	\$478
	B	HDW7820	Adj Univrsl Clamp (Pr)	\$427
	C	HDW7112T	12" Adjustment Rails (2)	\$65
	D	HDW1055	Std Seat To Back brkt	\$427
<p>Note: Configured to be ordered with SSK77XX or SSK78XX</p> <p>Note: When WC20 is added appropriate transit approved hardware must be selected.</p>				

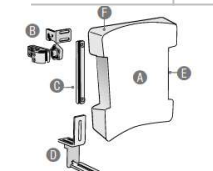
<input type="checkbox"/>	SBK78XX	E2617	Mount Hook & Fixed Hold (Forward)	\$1,854
				
	A	SBP11XX	Solid Back Insert	\$478
	B	HDW7820	Adj Univrsl Clamp (Pr)	\$427
	C	HDW7112T	12" Adjustment Rails (2)	\$65
	D	HDW1055	Std Seat To Back brkt	\$427
	E	MOD5200	I Style Back	\$182
	F	MOD5530	Curved Foam Back	\$275
<p>Note: Configured to be ordered with SSK77XX or SSK78XX</p> <p>Note: When WC20 is added appropriate transit approved hardware must be selected.</p>				

<b>SEATING SYSTEM TRANSIT OPTION</b>				
<input type="checkbox"/>	MODWC20		TRANSIT OPTION HARDWARE	\$327

**SEAT MODIFICATIONS**

**SEAT MODIFICATIONS – STRUCTURAL**

<input type="checkbox"/>	MOD4075		Two Piece Cushion & Base Seat	\$238
<input type="checkbox"/>	MOD4150		Notches for Back Posts 2" X 2"	N/C
<input type="checkbox"/>	MOD4153		Notches for Back Posts 3" deep	N/C
<input type="checkbox"/>	MOD4155		Notches Front Hangers (Wood Only)	N/C
<input type="checkbox"/>	MOD4159		Notches Back Post, Seat, Cus	\$58
<input type="checkbox"/>	MOD4170		Sub 1/2" Plastitech Seat	\$58
<input type="checkbox"/>	MOD4175		Mid Seat Cutout for X-Brace	\$159
<input type="checkbox"/>	MOD4200L		Offset Seat, Long on Left side	\$159
<input type="checkbox"/>	MOD4200R		Offset Seat, Long on Right side	\$159
<input type="checkbox"/>	MOD4300		T-style Seat	\$172
<input type="checkbox"/>	MOD4400		Anti-Thrust Seat	\$260
<input type="checkbox"/>	MOD4450		Quick-Fit Anti-Thrust Seat	\$615
<input type="checkbox"/>	MOD4460		Wedge Seat	\$269
<input type="checkbox"/>	MOD4500		Cubed Seat (2"x2"x2" HR foam)	\$615
<input type="checkbox"/>	MOD4525		Personalized Cubes, Seat	\$716
<input type="checkbox"/>	MOD4600	E2294	Contour Seat	\$521
<input type="checkbox"/>	MOD4605		Leg Trough Cut Into Seat	\$203
<input type="checkbox"/>	MOD4611		Contoured Mod w/Pel Well Mild	\$521
<input type="checkbox"/>	MOD4612		Contoured Mod w/Pel Well Med	\$521
<input type="checkbox"/>	MOD4613		Contoured Mod w/Pel Well Aggr	\$521
<input type="checkbox"/>	MOD4614		Contoured Mod w/Pel Well Cust	\$521
<input type="checkbox"/>	MOD4630		Quick-Fit Contoured Seat	\$795
<input type="checkbox"/>	MOD4640L		Lateral Reinforcement, Seat, Left	\$159
<input type="checkbox"/>	MOD4640R		Lateral Reinforcement, Seat, Right	\$159
<input type="checkbox"/>	MOD4650		Substitute ABS for Multi-Ply in Seat	\$216
<input type="checkbox"/>	MOD4655L		Belt Strap Notches, Seat, Left	\$32
<input type="checkbox"/>	MOD4655R		Belt Strap Notches, Seat, Right	\$32
<input type="checkbox"/>	MOD4700		Built-in Medial Thigh Support	\$310
<input type="checkbox"/>	MOD4725		Contour Lateral Adductor	\$310
<input type="checkbox"/>	MOD4800		Seat Rail Foam Overlay	\$191
<input type="checkbox"/>	MOD4825		Seat - Front Edge Bevel Undercut	\$191
<input type="checkbox"/>	MOD4850L		Pelvic Obliquity Addition (Up to 1") Left	\$216
<input type="checkbox"/>	MOD4850R		Pelvic Obliquity Addition (Up to 1") Right	\$216
<input type="checkbox"/>	MOD4900		Adjustable Split Seat	\$716
<input type="checkbox"/>	MOD5000		I-Style Seat	\$172
<input type="checkbox"/>	MOD5700		Substitute 3/4" Multi-Ply for 1/2"	\$103
<input type="checkbox"/>	MOD6827		No Seat Cushion	N/C
<input type="checkbox"/>	MOD6828		Add Folding Hinge Bracket	\$191
<input type="checkbox"/>	MOD6860L		SEAT MOUNT L brkt, TRANS, L	\$44
<input type="checkbox"/>	MOD6860R		SEAT MOUNT L brkt, TRANS, R	\$44
<input type="checkbox"/>	MOD6861L		SEAT MOUNT L brkt, TRANS, SH/L	\$44
<input type="checkbox"/>	MOD6861R		SEAT MOUNT L brkt, TRANS, SH/R	\$44
<input type="checkbox"/>	MOD8000		Omit T-Nuts	N/C

**SEAT MODIFICATIONS - UPHOLSTERY**

<input type="checkbox"/>	MOD4125		Attaching Strips, Bottom, Loop	\$58
<input type="checkbox"/>	MOD4125H		Attaching Strips, Bottom, Hook	\$58
<input type="checkbox"/>	MOD4126		Attaching Strips, Top, Hook	\$58
<input type="checkbox"/>	MOD4130		Non-Skid Added to Bottom	\$71
<input type="checkbox"/>	MOD4131		Non-Skid Added to Top	\$71
<input type="checkbox"/>	MOD5120		Add Velcro Closure, Made To Order	\$216
<input type="checkbox"/>	MOD5130		Add Synthetic Sheepskin To Cover, Std	\$260
<input type="checkbox"/>	MOD5150		Incontinent Film Covering	\$145
<input type="checkbox"/>	MOD5160		Rem Cover Zipper Bottom Seat	\$159
<input type="checkbox"/>	MOD5191		Rem Zippered Seat Face Cover	\$203
<input type="checkbox"/>	MOD5192		Add Zip Seat Top Face Only	\$191
<input type="checkbox"/>	MOD5600		Sewn Positioning Strap Slot (Pair)	\$159

**SEAT MODIFICATIONS - FOAM**

<input type="checkbox"/>	MOD0050		Omit Foam in Seat	N/C
<b>HR FOAM</b>				
<input type="checkbox"/>	MOD1005		1/2" HR Foam in Seat	N/C
<input type="checkbox"/>	MOD1100		1" HR Foam in Seat	N/C
<input type="checkbox"/>	MOD1150		1-1/2" HR Foam in Seat	N/C
<input type="checkbox"/>	MOD1200		2" HR Foam in Seat	\$51
<input type="checkbox"/>	MOD1300		3" HR Foam in Seat	\$71
<b>PUDGEE FOAM</b>				
<input type="checkbox"/>	MOD1405		Additional 1/2" Pudgee Foam in Seat	\$260
<input type="checkbox"/>	MOD1400		1" Pudgee Foam in Seat	\$390
<input type="checkbox"/>	MOD1495		1" Pudgee Foam Partial Insert	\$290
<b>T FOAM</b>				
<input type="checkbox"/>	MOD1605		1/2" T-Foam in Seat	\$87
<input type="checkbox"/>	MOD1600		1" T-Foam in Seat	\$151
<input type="checkbox"/>	MOD1615		1-1/2" T-Foam in Seat	\$172
<input type="checkbox"/>	MOD1700		2" T-Foam in Seat	\$216
<b>SUNMATE FOAM</b>				
<input type="checkbox"/>	MOD1805		1/2" SunMate Foam in Seat	\$65
<input type="checkbox"/>	MOD1800		1" SunMate Foam in Seat	\$124
<input type="checkbox"/>	MOD1815		1-1/2" SunMate Foam in Seat	\$159
<input type="checkbox"/>	MOD1900		2" SunMate Foam in Seat	\$182
<input type="checkbox"/>	MOD1816		1/2" SSM over 1" MSM Foam In seat	\$159
<input type="checkbox"/>	MOD1817		1" SSM over 1/2" MSM Foam in Seat	\$159
<b>JAY FLOW FLUID</b>				
<input type="checkbox"/>	MOD1505		Pressure Relief Pads/Ischial	\$376
<b>GEL</b>				
<input type="checkbox"/>	MOD1500		5/8" Gel over HR Foam in Seat	\$333
<input type="checkbox"/>	MOD1525		1/2" Cubed Gel over HR Foam in Seat	\$390
<input type="checkbox"/>	MOD1595		5/8" Gel Partial Insert	\$264
<b>STIMULITE HONEYCOMB</b>				
<input type="checkbox"/>	MOD1185		1/2" Stimulite Honeycomb, Seat	\$310
<input type="checkbox"/>	MOD1180		1" Stimulite Honeycomb, Seat	\$390
<input type="checkbox"/>	MOD1195		Partial Stimulite Honeycomb, Insert	\$310

**ADDITIONAL SEAT COVERS**

<input type="checkbox"/>	COV4100		Additional Zippered Cover, Flat, Std	\$191
<input type="checkbox"/>	COV4109		Additional Zippered Cover, Made To Order	\$260
<input type="checkbox"/>	COV4110		Additional Slip Over Cover, Flat, Std	\$191
<input type="checkbox"/>	COV4119		Additional Slip Over Cover, Made To Order	\$260
<input type="checkbox"/>	COV99XX		Additional Zippered Cover Foam Form	\$716

**BACK MODIFICATIONS**

**BACK MODIFICATIONS – STRUCTURAL**

<input type="checkbox"/>	MOD1045	Adj Offset Hinge, Wide in Pkg	\$124
<input type="checkbox"/>	MOD1055	Adj Offset Hinge, Ped in Pkg	\$124
<input type="checkbox"/>	MOD5075	2 Piece Cush & Base Back (1/2" Wood)	\$246
<input type="checkbox"/>	MOD5125	Add Hook/Loop Closure Back	\$210
<input type="checkbox"/>	MOD5135	Add Faux Sheepskin To Back	\$260
<input type="checkbox"/>	MOD5170	Sub 1/2" Plastitech Back	\$58
<input type="checkbox"/>	MOD5180	Foam Form Back	\$716
<input type="checkbox"/>	MOD5194	Cen & Top Edge Zip Hidn Back	N/C
<input type="checkbox"/>	MOD5200	I-Style Back	\$182
<input type="checkbox"/>	MOD5300	T-Style Back	\$182
<input type="checkbox"/>	MOD5425	Half-Round Lumbar Roll - Internal	\$253
<input type="checkbox"/>	MOD5426	Half-Round Lumbar Roll w/ Strap	\$253
<input type="checkbox"/>	MOD5450	Adj Angle Bi-Angular Back w/ 2 brkts	\$528
<input type="checkbox"/>	MOD5451	Adj Angle Bi-Angular Back w/ 1 brkt	\$348
<input type="checkbox"/>	MOD5452	Adj Bi-Ang Back 2 Piece cover	\$716
<input type="checkbox"/>	MOD5455	Sub 1/2" Plastitech Base & Cush, Back	\$93
<input type="checkbox"/>	MOD5460	Adjustable Lumbar Back 5.5" Adj Range	\$571
<input type="checkbox"/>	MOD5461	Adjustable Lumbar Back 3" Adj Range	\$571
<input type="checkbox"/>	MOD5462	Adjustable Lumbar Back 7.5" Adj Range	\$571
<input type="checkbox"/>	MOD5475	Revers Bi-Angular Back - Fixed	\$310
<input type="checkbox"/>	MOD5500	Curved Back	\$253
<input type="checkbox"/>	MOD5501	Curved Back, w/ 2 hinged L brkts	\$310
<input type="checkbox"/>	MOD5502	Curved Back, w/ 4 Hinged L brkts	\$340
<input type="checkbox"/>	MOD5510	Curved Lateral Thor Pad Mod	\$26
<input type="checkbox"/>	MOD5525	Rear Upright Foam Overlay	\$189
<input type="checkbox"/>	MOD5530	Curved Foam Addition to Flat Back	\$203
<input type="checkbox"/>	MOD5550	Cubed Back (2"x2"x2" HR foam)	\$586
<input type="checkbox"/>	MOD5575	Personalized Cubes, Back	\$716
<input type="checkbox"/>	MOD5600	Sewn Anterior Position Strap Slots (PR)	\$159
<input type="checkbox"/>	MOD5605	T-Nut For Strap Pos Hdw	N/C
<input type="checkbox"/>	MOD5610	Shoulder Strap Mnt Through Back	\$210
<input type="checkbox"/>	MOD5620	Attaching Tie W/Velcro Back	\$36
<input type="checkbox"/>	MOD5621	Attaching Tie W/ Snaps Back	\$32
<input type="checkbox"/>	MOD5622	Attaching Ties Loops Back	\$32
<input type="checkbox"/>	MOD5650	Substitute ABS (1/2") for Multi-Ply in Bck	\$260
<input type="checkbox"/>	MOD5700	Replace 3/4" Multi-Ply with 1/2"	\$101
<input type="checkbox"/>	MOD5705	Replace 1/2" Multi-Ply with 3/4"	\$101
<input type="checkbox"/>	MOD5800	Contour Back	\$441
<input type="checkbox"/>	MOD5801	Quick-Fit Contour/Bi-Angular Back	\$875
<input type="checkbox"/>	MOD5802	Quick-Fit Contour Back Only	\$716
<input type="checkbox"/>	MOD5804	Contour Fixed Lumbar Wedge	\$282
<input type="checkbox"/>	MOD5810	Contour Back Mod Euro Style	\$203
<input type="checkbox"/>	MOD5835	Harn's Strap Notches, Top Edge of Back	\$145
<input type="checkbox"/>	MOD5849	ABS back with side walls Back	\$398
<input type="checkbox"/>	MOD5850	Scapular Contour Cutout, Back	\$269
<input type="checkbox"/>	MOD5855	Top Edge Angle Cut, Back	\$159
<input type="checkbox"/>	MOD5860	Large Radius Corners For Back	N/C
<input type="checkbox"/>	MOD8100	Omit T-Nuts, Back	N/C

**BACK MODIFICATIONS – UPHOLSTERY**

<input type="checkbox"/>	MOD5115	Add Faux Sheepskin to Back Cus	\$317
<input type="checkbox"/>	MOD5125	Add Velcro Closure, Made To Order	\$210
<input type="checkbox"/>	MOD5127	Privacy Flap 12" Long	\$159
<input type="checkbox"/>	MOD5165	Removable top Cover Zipper at Center	\$216
<input type="checkbox"/>	MOD5610	Shoulder Strap Mounting Grommets	\$210
<input type="checkbox"/>	MOD5620	Attaching Ties for Back, Velcro	\$36
<input type="checkbox"/>	MOD5621	Attaching Ties for Back, Snaps	\$32
<input type="checkbox"/>	MOD5900	Monogram Back, Block	N/C
<input type="checkbox"/>	MOD5901	Monogram Back, Script	N/C
<input type="checkbox"/>	MOD5902	Monogram Stock Design	N/C
<input type="checkbox"/>	MOD5909	Monogram Back, Personalized	N/C

**BACK MODIFICATIONS – FOAM**

<input type="checkbox"/>	MOD0055	Omit Foam in Back	N/C	
<b>HR FOAM</b>				
<input type="checkbox"/>	MOD2005	1/2" HR Foam in Back	NC	
<input type="checkbox"/>	MOD2100	1" HR Foam in Back	NC	
<input type="checkbox"/>	MOD2150	1-1/2" HR Foam in Back	NC	
<input type="checkbox"/>	MOD2200	2" HR Foam in Back	\$51	
<input type="checkbox"/>	MOD2300	3" HR Foam in Back	\$80	
<b>PUDGEE FOAM</b>				
<input type="checkbox"/>	MOD2400	1" Pudgee Foam in Back	\$370	
<input type="checkbox"/>	MOD2405	Additional 1/2" Pudgee Foam in Back	\$260	
<input type="checkbox"/>	MOD2495	1" Partial Pudgee Foam in Back	\$290	
<b>T FOAM</b>				
<input type="checkbox"/>	MOD2605	1/2" T-Foam in Back	\$87	
<input type="checkbox"/>	MOD2600	1" T-Foam in Back	\$151	
<input type="checkbox"/>	MOD2615	1-1/2" T-Foam in Back	\$172	
<input type="checkbox"/>	MOD2700	2" T-Foam in Back	\$210	
<b>SUNMATE FOAM</b>				
<input type="checkbox"/>	MOD2805	1/2" SunMate in Back	\$65	
<input type="checkbox"/>	MOD2800	1" SunMate Foam in Back	\$138	
<input type="checkbox"/>	MOD2815	1-1/2" SunMate in Back	\$151	
<input type="checkbox"/>	MOD2900	2" SunMate Foam in Back	\$189	
<input type="checkbox"/>	MOD2801	1/2" SSM OVER 1/2" MSM, BACK	\$138	
<input type="checkbox"/>	MOD2804	1" SSM OVER 1/2" HR FOAM, BACK	\$138	
<b>JAY FLOW FLUID</b>				
<input type="checkbox"/>	MOD2505	Spinal Pressure Relief Pad	\$534	
<b>GEL</b>				
<input type="checkbox"/>	MOD2160	Elasto-Gel Addition Back	\$521	
<input type="checkbox"/>	MOD2500	5/8" Gel & HR Foam in Back	\$348	
<input type="checkbox"/>	MOD2595	5/8" Gel Partial & HR Foam in Back	\$290	
<b>STIMILITE HONEYCOMB</b>				
<input type="checkbox"/>	MOD2185	1/2" Stimulite in Back	\$290	
<input type="checkbox"/>	MOD2180	1" Stimulite in Back	\$412	
<input type="checkbox"/>	MOD2195	Partial Stimulite in Back	\$275	
<b>FOAM-IN-PLACE</b>				
<input type="checkbox"/>	MOD5180	Foam-in-Place BACK Soft	\$716	
<b>BACK MODIFICATIONS - INTERNAL</b>				
<input type="checkbox"/>	FTK10XX	E0956	Thrcic Support Kit Foam Form 5"Hx5"D	\$478
<input type="checkbox"/>	FTK11XX	E0956	Thrcic Support Kit Foam Form 7"Hx5"D	\$571
<input type="checkbox"/>	FTK12XX	E0956	Thrcic Support Kit Foam Form 9"Hx6"D	\$434
<input type="checkbox"/>	FTK13XX	E0956	Thrcic Support Kit Foam Form 11"Hx7"D	\$478
<input type="checkbox"/>	FTK19XX		Thrcic Support Kit, Foam Form, Made To Order	\$807

**ADDITIONAL BACK COVERS**

<input type="checkbox"/>	COV5100	Additional Zippered Cover, Flat, Std	\$195
<input type="checkbox"/>	COV5109	Additional Zippered Cover, Made To Order	\$275
<input type="checkbox"/>	COV5110	Additional Slip Over Cover, Flat, Std	\$203
<input type="checkbox"/>	COV5119	Additional Slip Over Cover, Made To Order	\$282
<input type="checkbox"/>	COV99XX	Add Zipper Cover Foam-in-place	\$716

**LATERAL THORACIC SUPPORTS**

<b>LATERAL THORACIC SUPPORT PACKAGES - Each</b>				
<input type="checkbox"/>	LTK72XX	E0956	Std profile bracket - Flat Pad - Each	\$195
	<input type="checkbox"/> Left		<input type="checkbox"/> Right <input type="checkbox"/> Pair	
<input type="checkbox"/>	LTK73XX	E0956	Std profile bracket - Curved Pad - Each	\$275
	<input type="checkbox"/> Left		<input type="checkbox"/> Right <input type="checkbox"/> Pair	
<input type="checkbox"/>	LTK74XX	E0956	Fixed Modular brkt - Flat Pad - Each	\$390
	<input type="checkbox"/> Left		<input type="checkbox"/> Right <input type="checkbox"/> Pair	
<input type="checkbox"/>	LTK75XX	E0956 E1028	E-Z Access SA brkt - Flat Pad - Each	\$521
	<input type="checkbox"/> Left		<input type="checkbox"/> Right <input type="checkbox"/> Pair	
<input type="checkbox"/>	LTK76XX	E0956 E1028	Modular brkt Quick Adj - Flat Pad - Each	\$462
	<input type="checkbox"/> Left		<input type="checkbox"/> Right <input type="checkbox"/> Pair	
<input type="checkbox"/>	LTK77XX	E0956 E1028	E-Z Access SA brkt Q Adj - Flat Pad - EA	\$592
	<input type="checkbox"/> Left		<input type="checkbox"/> Right <input type="checkbox"/> Pair	
<input type="checkbox"/>	LTK78XX	E0956 E1028	E-Z Access SA brkt - Curved Pad - Each	\$521
	<input type="checkbox"/> Left		<input type="checkbox"/> Right <input type="checkbox"/> Pair	

<b>LATERAL THORACIC SUPPORT MODIFICATIONS</b>				
<input type="checkbox"/>	MOD2550		1/4" Gel in Thoracic Support	\$71
<input type="checkbox"/>	MOD2650		1/2" T-Foam in Thoracic Support	\$58
<input type="checkbox"/>	MOD2750		1/2" Pudgee in Thoracic Support	\$71
<input type="checkbox"/>	MOD2850		1/2" SunMate in Thoracic Support	\$25
<input type="checkbox"/>	MOD2861		1" SunMate in Thoracic Support	\$25
<input type="checkbox"/>	MOD2950		Taper Front Edge of Thoracic Support	\$25
<input type="checkbox"/>	MOD3000		Replace Multi-Ply with ABS	\$17
<input type="checkbox"/>	MOD3001		Flat Metal Base up to 5x6"	\$36
<input type="checkbox"/>	MOD3011		Curved Metal Base up to 5X6"	\$36
<input type="checkbox"/>	MOD3100		Add Waterfall Foam to Thoracic Support	\$71
<input type="checkbox"/>	MOD3150		Contour-Fit Pad	\$93
<input type="checkbox"/>	MOD3175		Hinged Pad	\$238
<input type="checkbox"/>	MOD5510		Curved Lateral Pad	\$26
<input type="checkbox"/>	MOD6803		Curved Back Bracket	NC

<b>LATERAL THORACIC ADDITIONAL HARDWARE AND COVERS</b>				
<input type="checkbox"/>	HDW2025		1/4" Bracket Spacer	\$26
<input type="checkbox"/>	HDW2050		1/2" Bracket Spacer	\$26
<input type="checkbox"/>	HDW2521		1" Height Adapter Plate	\$46
<input type="checkbox"/>	HDW2522		2" Height Adapter Plate	\$46
<input type="checkbox"/>	HDW2523		3" Height Adapter Plate	\$46
<input type="checkbox"/>	COV2656		Lateral Bracket Fabric Cover (Ped)	\$48
<input type="checkbox"/>	COV2666		Lateral Bracket Fabric Cover (Short)	\$48
<input type="checkbox"/>	COV2657		Lateral Bracket Fabric Cover (1" Offset)	\$48
<input type="checkbox"/>	COV2667		Lateral Bracket Fabric Cover (2" Offset)	\$48

**LATERAL PELVIC/THIGH SUPPORTS**

<b>LATERAL PELVIC/THIGH SUPPORT PACKAGES - Each - Pad up to</b>				
<i>Note: Pads can be built up to 5" High and 18" Long</i>				
<input type="checkbox"/>	LPK72XX	E0956	Standard profile brkt w/ Pad - Each	\$210
	<input type="checkbox"/> Left		<input type="checkbox"/> Right <input type="checkbox"/> Pair	
<input type="checkbox"/>	LPK74XX	E0956	Modular brkt w/ Pad - Each	\$333
	<input type="checkbox"/> Left		<input type="checkbox"/> Right <input type="checkbox"/> Pair	
<input type="checkbox"/>	LPK75XX	E0956	20° Adj brkt w/ Pad - Each	\$398
	<input type="checkbox"/> Left		<input type="checkbox"/> Right <input type="checkbox"/> Pair	
<input type="checkbox"/>	LPK76XX	E0956	High Profile brkt w/ Pad - Each	\$227
	<input type="checkbox"/> Left		<input type="checkbox"/> Right <input type="checkbox"/> Pair	
<input type="checkbox"/>	LPK77XX	E0956 E1028	Removable brkt w/ Pad - Each	\$455
	<input type="checkbox"/> Left		<input type="checkbox"/> Right <input type="checkbox"/> Pair	
<input type="checkbox"/>	LPK78XX	E0956 E1028	Removable 20° Adj brkt w/ Pad - Each	\$521
	<input type="checkbox"/> Left		<input type="checkbox"/> Right <input type="checkbox"/> Pair	

<b>LATERAL PELVIC/THIGH SUPPORT MODIFICATIONS</b>				
<input type="checkbox"/>	MOD3025		D Forward Pad Shape	NC
<input type="checkbox"/>	MOD3050		Replace Multi-Ply with ABS	\$17
<input type="checkbox"/>	MOD3055		Contoured Pelvic Supports (Anti-Thrust)	\$80
<input type="checkbox"/>	MOD3500		Waterfall Foam Pelvic Support	\$65
<input type="checkbox"/>	MOD3550		1/4" Gel in Pelvic Support	\$71
<input type="checkbox"/>	MOD3551		1/4" Gel in Long Pelvic Support	\$87
<input type="checkbox"/>	MOD3650		1/2" T-Foam in Pelvic Support	\$58
<input type="checkbox"/>	MOD3750		1/2" Pudgee in Pelvic Support	\$80
<input type="checkbox"/>	MOD3850		1/2" SunMate in Pelvic Support	\$58
<input type="checkbox"/>	MOD3861		1" SunMate in Pelvic Support	\$25
<input type="checkbox"/>	MOD3858		Distal Edge Contour	\$145
<input type="checkbox"/>	MOD3870		Mount LPK on Flat Back Surface	NC
<input type="checkbox"/>	MOD3899		Cus Foam Mod Pelvic Thigh Sup	\$87
<input type="checkbox"/>	MOD4750L		Long, Curved Pad, Pelvic/Thigh left	\$26
<input type="checkbox"/>	MOD4750R		Long, Curved Pad, Pelvic/Thigh, right	\$26

<b>ADDITIONAL DISTAL HARDWARE</b>				
<input type="checkbox"/>	HDW2527		2" Distal Ext Adapter Bar	\$51
<input type="checkbox"/>	HDW2528		3" Distal Ext Adapter Bar	\$51

**MEDIAL THIGH SUPPORTS**

<b>MEDIAL THIGH SUPPORT PACKAGES</b>				
<input type="checkbox"/>	MTK31XX	E0957 E1028	Pull-Away brkt, 1.25" to 2.75" adj	\$716
<input type="checkbox"/>	MTK34XX	E0957 E1028	Pull-Away brkt, 2.75" to 4.25" adj	\$716

<b>MEDIAL THIGH SUPPORT MODIFICATIONS</b>				
<input type="checkbox"/>	MOD3855		1/2" SunMate Foam in Medial Support	STD
<input type="checkbox"/>	MOD3856		1" SunMate Foam in Medial Support	\$69
<input type="checkbox"/>	MOD3555		1/4" Gel in Medial Support	\$189
<input type="checkbox"/>	MOD3655		1/2" T-Foam in Medial Support	\$58
<input type="checkbox"/>	MOD3755		1/2" Pudgee Foam in Medial Support	\$189

**PELVIC POSITIONING BELTS**

**ANTERIOR PELVIC POSITIONING BELTS – SINGLE PULL**

<input type="checkbox"/>	APB6212	E0978	1.5" Side Release buckle, 7.5" Pads	\$63
<input type="checkbox"/>	APB6213	E0978	1.5" Side Release buckle, 9.5" Pads	\$63
<input type="checkbox"/>	APB6210	E0978	1.5" Side Release buckle, Non-Padded	\$41
<input type="checkbox"/>	APB7212	E0978	1.5" Push-Button buckle, Small Pads	\$99
<input type="checkbox"/>	APB7213	E0978	1.5" Push-Button buckle, Med Pads	\$99
<input type="checkbox"/>	APB7210	E0978	1.5" Push-Button buckle, Non-Padded	\$47
<input type="checkbox"/>	APB5115	E0978	Li'l Kiddos 1" Push Button, 4.5" Pads	\$145
<input type="checkbox"/>	APB5116	E0978	Li'l Kiddos 1" Push Button, 5.5" Pads	\$145
<input type="checkbox"/>	APB5117	E0978	Li'l Kiddos 1" Push Button, 7.5" Pads	\$145
<input type="checkbox"/>	APB5110	E0978	Li'l Kiddos 1" Push Button, No-Pad	\$47
<input type="checkbox"/>	APB6111	E0978	Li'l Kiddos 1" Release buckle 5.5" Pads	\$63
<input type="checkbox"/>	APB6112	E0978	Li'l Kiddos 1" Release buckle 7.5" Pads	\$63
<input type="checkbox"/>	APB6110	E0978	Li'l Kiddos 1" Release buckle, No-Pad	\$41

**ANTERIOR PELVIC POSITIONING BELTS – MEDIAL 4-POINT**

<input type="checkbox"/>	APB7242	E0978	1.5" Push-Button buckle, 4.5" Pads	\$127
<input type="checkbox"/>	APB7243	E0978	1.5" Push-Button buckle, 5.5" Pads	\$127
<input type="checkbox"/>	APB7244	E0978	1.5" Push-Button buckle, 6.5" Pads	\$127
<input type="checkbox"/>	APB5145	E0978	Li'l Kiddos 1" Push-button 3.5" Pads	\$127
<input type="checkbox"/>	APB5146	E0978	Li'l Kiddos 1" Push-button 4.5" Pads	\$127

**ANTERIOR PELVIC POSITIONING BELTS – DUAL PULL**

<input type="checkbox"/>	APB6222	E0978	1.5" Side Release buckle, Small Pads	\$63
<input type="checkbox"/>	APB6223	E0978	1.5" Side Release buckle, Med Pads	\$63
<input type="checkbox"/>	APB7221	E0978	1.5" Push-Button buckle, 5.5" Pads	\$99
<input type="checkbox"/>	APB7222	E0978	1.5" Push-Button buckle, 7.5" Pads	\$99
<input type="checkbox"/>	APB7223	E0978	1.5" Push-Button buckle, 9.5" Pads	\$99
<input type="checkbox"/>	APB5125	E0978	Li'l Kiddos 1" Push Button, 4.5" Pads	\$103
<input type="checkbox"/>	APB5126	E0978	Li'l Kiddos 1" Push Button, 5.5" Pads	\$103
<input type="checkbox"/>	APB5127	E0978	Li'l Kiddos 1" Push Button, 7.5" Pads	\$103
<input type="checkbox"/>	APB6121	E0978	Li'l Kiddos 1" Release buckle, 5.5" Pads	\$63
<input type="checkbox"/>	APB6122	E0978	Li'l Kiddos 1" Release buckle, 7.5" Pads	\$63

**ANTERIOR PELVIC POSITIONING BELTS – 4-POINT V-Contour**

<input type="checkbox"/>	APB3716	E0978	1" Push-Button buckle	\$192
<input type="checkbox"/>	APB3727	E0978	1.5" Push-Button buckle	\$192
<input type="checkbox"/>	APB3616	E0978	1" Release buckle	\$192
<input type="checkbox"/>	APB3627	E0978	1.5" Release buckle	\$192

**ANTERIOR TRUNK SUPPORTS**

**ANTERIOR TRUNK SUPPORTS – CLASSIC STYLE**

<input type="checkbox"/>	ATS8100	E0960	Dynamic, X-Small	\$174
<input type="checkbox"/>	ATS8101	E0960	Dynamic, Small	\$174
<input type="checkbox"/>	ATS8102	E0960	Dynamic, Medium	\$174
<input type="checkbox"/>	ATS8300	E0960	Structured, X-Small	\$174
<input type="checkbox"/>	ATS8301	E0960	Structured, Small	\$174
<input type="checkbox"/>	ATS8302	E0960	Structured, Medium	\$174

**ANTERIOR TRUNK SUPPORTS – CONTOUR STYLE**

<input type="checkbox"/>	ATS9100	E0960	Dynamic, X-Small	\$174
<input type="checkbox"/>	ATS9101	E0960	Dynamic, Small	\$174
<input type="checkbox"/>	ATS9102	E0960	Dynamic, Medium	\$174
<input type="checkbox"/>	ATS9107	E0960	Dynamic, Early Intervention	\$174
<input type="checkbox"/>	ATS9300	E0960	Structured, X-Small	\$174
<input type="checkbox"/>	ATS9301	E0960	Structured, Small	\$174
<input type="checkbox"/>	ATS9302	E0960	Structured, Medium	\$174

**ANTERIOR TRUNK SUPPORTS – CENTER OPENING STYLE**

<input type="checkbox"/>	ATS8807	E0960	Dynamic, Early Int - Side Rel Buckle	\$174
<input type="checkbox"/>	ATS8800	E0960	Dynamic, X-Small - Side Rel Buckle	\$174
<input type="checkbox"/>	ATS8801	E0960	Dynamic, Small - Side Rel Buckle	\$174
<input type="checkbox"/>	ATS8802	E0960	Dynamic, Medium - Side Rel Buckle	\$174
<input type="checkbox"/>	ATS8809	E0960	Dynamic, Made To Order - Side Rel Buckle	\$292
<input type="checkbox"/>	ATS9407	E0960	Structured, Early Int - Side Rel Buckle	\$174
<input type="checkbox"/>	ATS9400	E0960	Structured, X-Small - Side Rel Buckle	\$174
<input type="checkbox"/>	ATS9401	E0960	Structured, Small - Side Rel Buckle	\$174
<input type="checkbox"/>	ATS9402	E0960	Structured, Medium - Side Rel Buckle	\$174
<input type="checkbox"/>	ATS9409	E0960	Structured, Made To Order - Side Rel Buckle	\$292
<input type="checkbox"/>	ATS8701	E0960	Dynamic, Small - Zipper	\$174
<input type="checkbox"/>	ATS8702	E0960	Dynamic, Medium - Zipper	\$174
<input type="checkbox"/>	ATS8709	E0960	Dynamic, Made To Order - Zipper	\$292

**ANTERIOR TRUNK SUPPORTS – Y STYLE**

<input type="checkbox"/>	ATS9167	E0960	Dynamic, Early Intervention	\$156
<input type="checkbox"/>	ATS9161	E0960	Dynamic, Small	\$156
<input type="checkbox"/>	ATS9162	E0960	Dynamic, Medium	\$156
<input type="checkbox"/>	ATS9169	E0960	Dynamic, Made To Order	\$292
<input type="checkbox"/>	ATS9367	E0960	Structured, Early Intervention	\$156
<input type="checkbox"/>	ATS9361	E0960	Structured, Small	\$156
<input type="checkbox"/>	ATS9362	E0960	Structured, Medium	\$156
<input type="checkbox"/>	ATS9369	E0960	Structured, Made To Order	\$292

**ANTERIOR TRUNK SUPPORTS – TRUNK STRAP**

<input type="checkbox"/>	ATS4050	E0960	X-Small	\$162
<input type="checkbox"/>	ATS4000	E0960	Small	\$162
<input type="checkbox"/>	ATS4100	E0960	Medium	\$162
<input type="checkbox"/>	ATS4900	E0960	Made To Order	\$292

**ANTERIOR TRUNK SUPPORTS – BACK PACK STYLE**

<input type="checkbox"/>	ATS9601	E0960	Dynamic, 12"	\$156
<input type="checkbox"/>	ATS9603	E0960	Dynamic, 18"	\$156
<input type="checkbox"/>	ATS9609	E0960	Dynamic, Made To Order	\$292
<input type="checkbox"/>	ATS9701	E0960	Structured, 12"	\$156
<input type="checkbox"/>	ATS9703	E0960	Structured, 18"	\$156
<input type="checkbox"/>	ATS9709	E0960	Structured, Made To Order	\$292

**ANTERIOR TRUNK SUPPORTS – STRAP GUIDES**

<input type="checkbox"/>	HDW6900		STRAP POSITIONER - EACH	\$43
--------------------------	---------	--	-------------------------	------

**LOWER BODY POSITIONING**

**KNEE POSITIONING**

<input type="checkbox"/>	KPG10XX	E0953	Knee Pos Blocks, + Pullaway Hardware	\$605
<input type="checkbox"/>	KPG19XX	E0953	Knee Pos Blocks, Made To Order + Hardwar	\$671
<input type="checkbox"/>	KAK31XXL	E0953/E1028	Knee Add PKG Swing Away Long L	\$406
<input type="checkbox"/>	KAK31XXR	E0953/E1028	Knee Add PKG Swing Away Long R	\$406
<input type="checkbox"/>	KAK21XXL	E0953/E1028	Knee Add PKG Swing Away Short L	\$406
<input type="checkbox"/>	KAK21XXR	E0953/E1028	Knee Add PKG Swing Away Short R	\$406
<input type="checkbox"/>	KAD10XX	E0953	Knee Adductor Pad 3" Round	\$62
<input type="checkbox"/>	KAD11XX	E0953	Knee Adductor Pad 4" Round	\$62
<input type="checkbox"/>	KAD19XX	E0953	Knee Adductor Pad Made To Order	\$134
<input type="checkbox"/>	HDW4851	E1028	Knee Add brkt Swing Away Long L	\$441
<input type="checkbox"/>	HDW4852	E1028	Knee Add brkt Swing Away Long R	\$441
<input type="checkbox"/>	HDW4853	E1028	Knee Add brkt Swing Away Short L	\$441
<input type="checkbox"/>	HDW4854	E1028	Knee Add brkt Swing Away Short R	\$441

**FOOT BOXES**

<input type="checkbox"/>	TST7014L	E0954	Single Foot Box, Std, 14" W/C (left leg)	\$365
<input type="checkbox"/>	TST7014R	E0954	Single Foot Box, Std, 14" W/C (right leg)	\$365
<input type="checkbox"/>	TST7016L	E0954	Single Foot Box, Std, 16" W/C (left leg)	\$365
<input type="checkbox"/>	TST7016R	E0954	Single Foot Box, Std, 16" W/C (right leg)	\$365
<input type="checkbox"/>	TST7018L	E0954	Single Foot Box, Std, 18" W/C (left leg)	\$365
<input type="checkbox"/>	TST7018R	E0954	Single Foot Box, Std, 18" W/C (right leg)	\$365
<input type="checkbox"/>	TST7114	E0954	Full Width Ft Box, Std, 14" W/C (1 pc)	\$595
<input type="checkbox"/>	TST7116	E0954	Full Width Ft Box, Std, 16" W/C (1 pc)	\$595
<input type="checkbox"/>	TST7118	E0954	Full Width Ft Box, Std, 18" W/C (1 pc)	\$595

**FLEXI FEET**

<input type="checkbox"/>	32600XS-RT	E0951/E0952	Flexi-Feet System Xtra Small - Pair	\$261
<input type="checkbox"/>	32600S-RT	E0951/E0952	Flexi-Feet System Small - Pair	\$261
<input type="checkbox"/>	32600M-RT	E0951/E0952	Flexi-Feet System Medium - Pair	\$261
<input type="checkbox"/>	32600L-RT	E0951/E0952	Flexi-Feet System Large - Pair	\$261

**SHOE HOLDERS**

<input type="checkbox"/>	TST6001	E0951/E0952	Shoe Holder padded buckles Small	\$81
<input type="checkbox"/>	TST6101	E0951/E0952	Shoe Holder padded buckles Medium	\$81
<input type="checkbox"/>	TST6201	E0951/E0952	Shoe Holder padded buckles Large	\$81
<input type="checkbox"/>	TST6000	E0951/E0952	Shoe Holder non-padded buckles Small	\$73
<input type="checkbox"/>	TST6100	E0951/E0952	Shoe Holder non-padded buckles Med	\$73
<input type="checkbox"/>	TST6200	E0951/E0952	Shoe Holder non-padded buckles Large	\$73

**SHOE HOLDERS with TENDON RELIEF**

<input type="checkbox"/>	TST6061	E0951/E0952	Shoe Holder padded buckles Small	\$374
<input type="checkbox"/>	TST6161	E0951/E0952	Shoe Holder padded buckles Medium	\$379
<input type="checkbox"/>	TST6261	E0951/E0952	Shoe Holder padded buckles Large	\$384

**FOOT and ANKLE POSTIONING**

<input type="checkbox"/>	TST6510L	E0951/E0952	Foot & Ankle Positioner Small Left	\$104
<input type="checkbox"/>	TST6510R	E0951/E0952	Foot & Ankle Positioner Small Right	\$104
<input type="checkbox"/>	TST6520L	E0951/E0952	Foot & Ankle Positioner Medium Left	\$104
<input type="checkbox"/>	TST6520R	E0951/E0952	Foot & Ankle Positioner Medium Right	\$104
<input type="checkbox"/>	TST6540L	E0951/E0952	Foot & Ankle Positioner Large Left	\$104
<input type="checkbox"/>	TST6540R	E0951/E0952	Foot & Ankle Positioner Large Right	\$104

**ANKLE POSTIONING**

<input type="checkbox"/>	TST6501L	E0951	Ankle Positioner Xtra Small Left	\$81
<input type="checkbox"/>	TST6501R	E0951	Ankle Positioner Xtra Small Right	\$81
<input type="checkbox"/>	TST6511L	E0951	Ankle Positioner Small Left	\$81
<input type="checkbox"/>	TST6511R	E0951	Ankle Positioner Small Right	\$81
<input type="checkbox"/>	TST6521L	E0951	Ankle Positioner Medium Left	\$81
<input type="checkbox"/>	TST6521R	E0951	Ankle Positioner Medium Right	\$81
<input type="checkbox"/>	TST6541L	E0951	Ankle Positioner Large Left	\$81
<input type="checkbox"/>	TST6541R	E0951	Ankle Positioner Large Right	\$81

**UPPER BODY POSITIONING**

**TRAYS**

<input type="checkbox"/>	WCT1005	E0950	Wooden Support Platform, X-Small	\$333
<input type="checkbox"/>	WCT1000	E0950	Wooden Support Platform, Small	\$333
<input type="checkbox"/>	WCT2000	E0950	Wooden Support Platform, Medium	\$333
<input type="checkbox"/>	WCT3000	E0950	Wooden Support Platform, Large	\$333
<input type="checkbox"/>	WCT4000	E0950	Wooden Support Platform, X-Large	\$333
<input type="checkbox"/>	WCT5005	E0950	Lexan Support Platform, X-Small	\$344
<input type="checkbox"/>	WCT5000	E0950	Lexan Support Platform, Small	\$344
<input type="checkbox"/>	WCT6000	E0950	Lexan Support Platform, Medium	\$344
<input type="checkbox"/>	WCT7000	E0950	Lexan Support Platform, Large	\$344
<input type="checkbox"/>	WCT8000	E0950	Lexan Support Platform, X-Large	\$344
<input type="checkbox"/>	WCT9000	E0950	Made To Order Support Platform	\$628

**TRAY MOUNTING HARDWARE**

<input type="checkbox"/>	THW1000		Toggle Hardware	\$74
<input type="checkbox"/>	THW2000		Slide Tube Hardware	\$218
<input type="checkbox"/>	THW3000		Birch Runners	\$49
<input type="checkbox"/>	THW3100		S-Style Runners, ABS	\$49
<input type="checkbox"/>	THW3210		Slotted Channel Runners, ABS	\$54
<input type="checkbox"/>	THW3700		Top Drop Platform	\$144
<input type="checkbox"/>	THW4500		Angle-Cam Hardware	\$74

**NOTES**

---

---

---

---

---

---

---

---

**PLATFORM ACCESSORIES**

<input type="checkbox"/>	TAC11XX		Platform Padding, Removable Cover	\$386
<input type="checkbox"/>	TAC4100L		Joystick Cutout, Left	\$78
<input type="checkbox"/>	TAC4100R		Joystick Cutout, Right	\$78
<input type="checkbox"/>	TAC4175		Platform Cutout, Made To Order	\$100
<input type="checkbox"/>	THW6000		Strap with Release Buckle	\$62

**SEAT DIMENSIONS Specifications**

**SOLID SEAT INSERT**

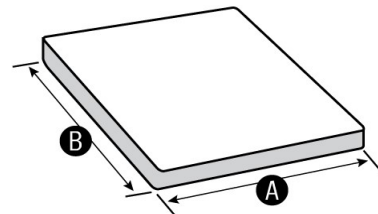

<b>A</b>	
<b>B</b>	

**I STYLE SEAT INSERT**

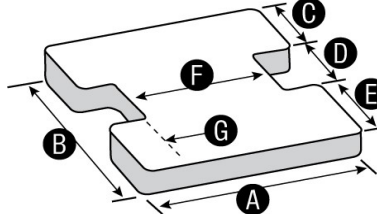

<b>A</b>	
<b>B</b>	
<b>C</b>	
<b>D</b>	
<b>E</b>	
<b>F</b>	
<b>G</b>	

**T STYLE SEAT INSERT**

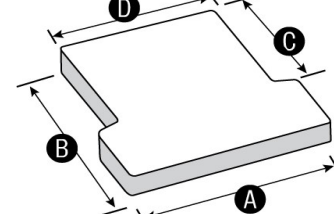

<b>A</b>	
<b>B</b>	
<b>C</b>	
<b>D</b>	

**OFFSET SEAT INSERT**

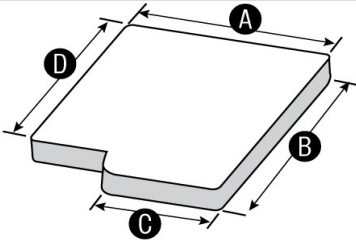

- Long Left Side
- Long Right Side

A	C
B	D

**ANTI-THRUST SEAT INSERT**

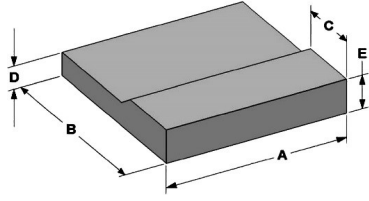

A	D
B	E
C	

**ADJUSTABLE SPLIT SEAT INSERT**

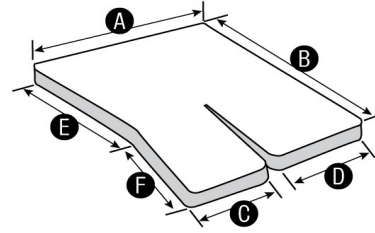

A	D
B	E
C	F

**BUILT-IN MEDIAL THIGH SUPPORT**

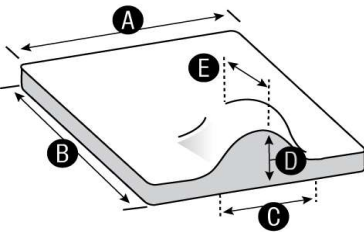

A	D
B	E
C	

**CONTOUR SEAT INSERT**

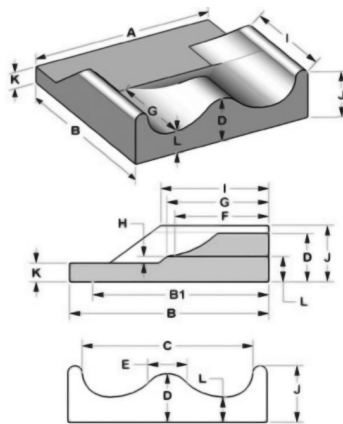

A	G
B	H
C	I
D	J
E	K
F	L

**BACK DIMENSIONS Specifications**

**SOLID BACK INSERT**

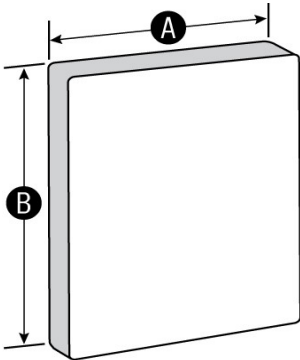

A	B
---	---

**I STYLE BACK INSERT**

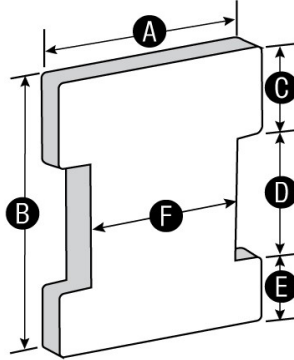

A	D
B	E
C	F

**T STYLE BACK INSERT**

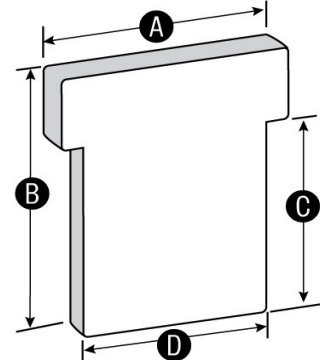

A	C
B	D



BI-ANGULAR BACK INSERT

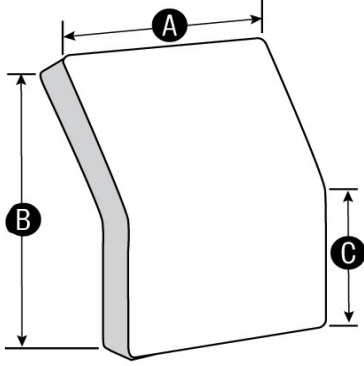

A
B

C
---

CURVED BACK INSERT

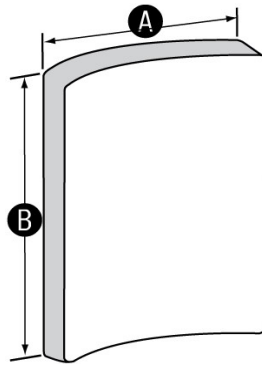

A
---

B
---

ADJ LUMBAR SUPPORT BK INSERT

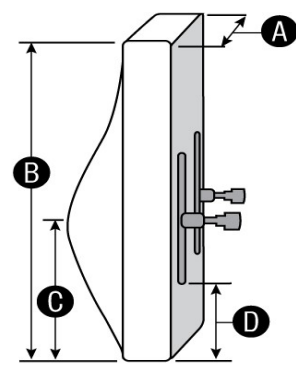

A
B

C
D

CONTOUR BACK INSERT

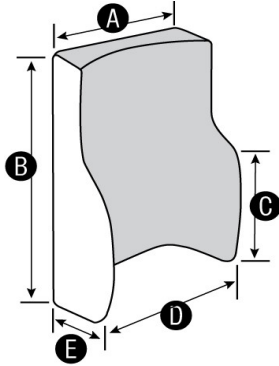

A
B
C

D
E



Sunrise Medical (US) LLC  
2842 Business Park Ave. · Fresno, CA 93727 · USA